

Papel: Din A4

1 Se construye la base

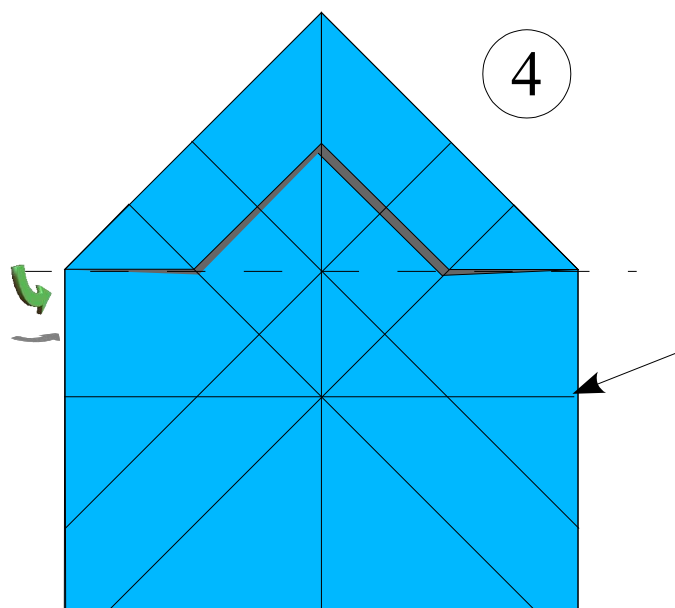
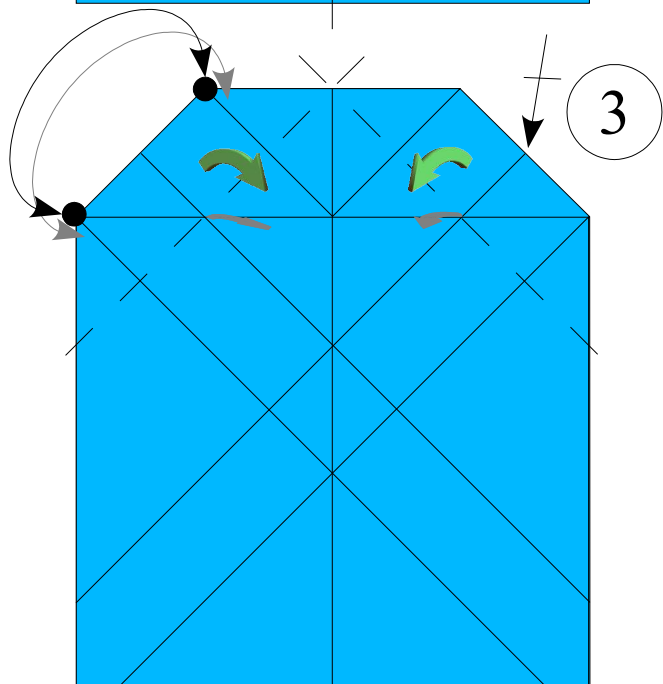
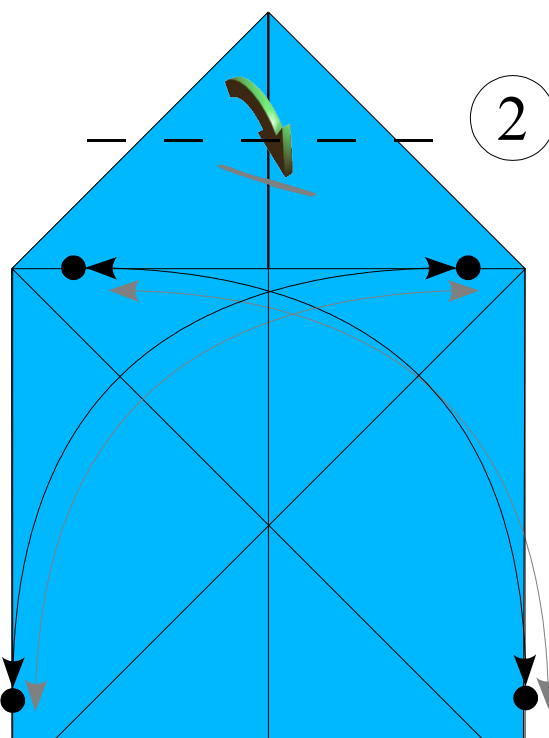
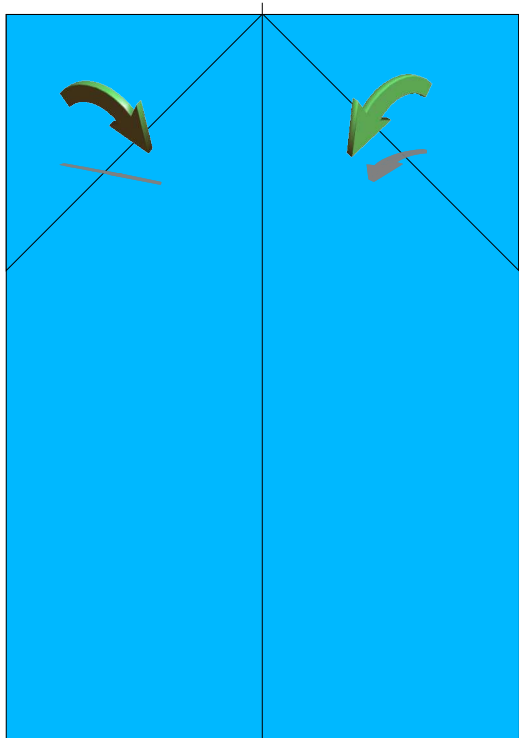

5

6

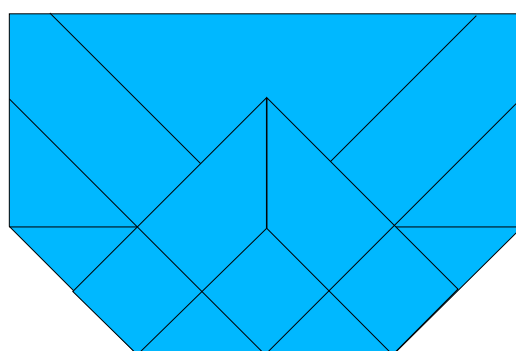
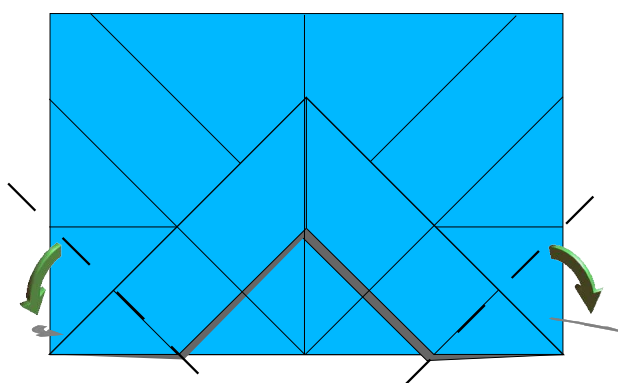

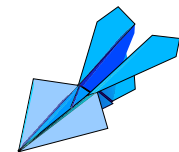

Desplegamos. Base final

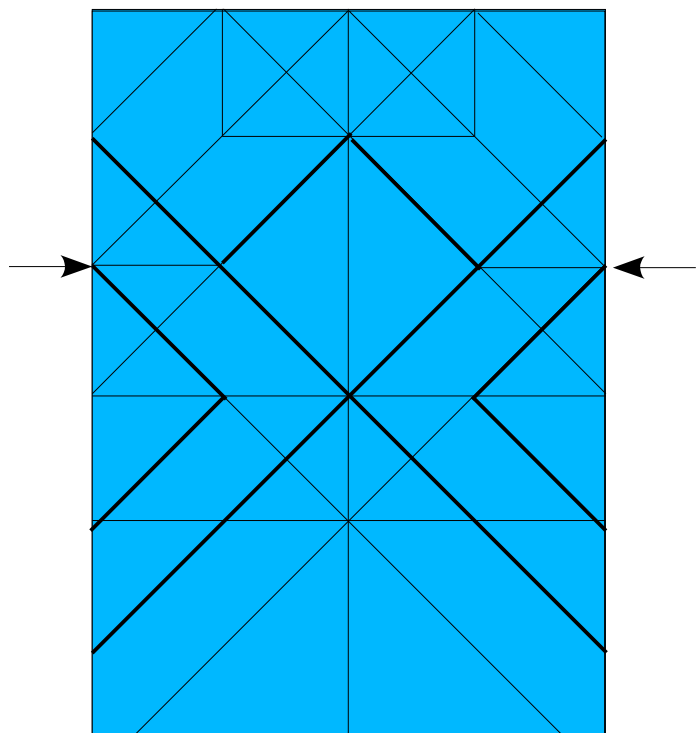

8

Volvemos al pliegue del paso 3 7

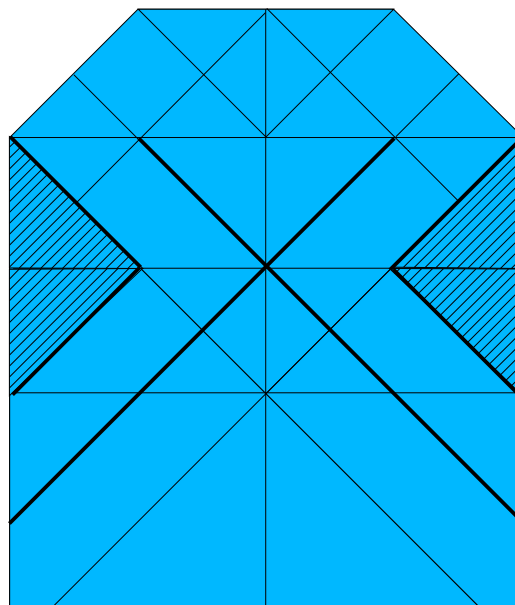

8a

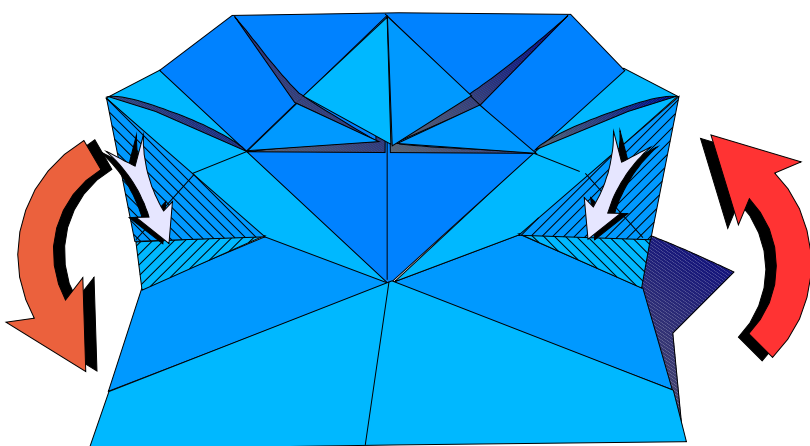

8b

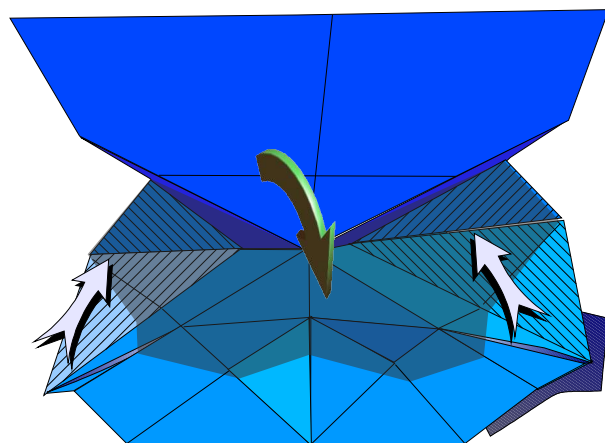

9

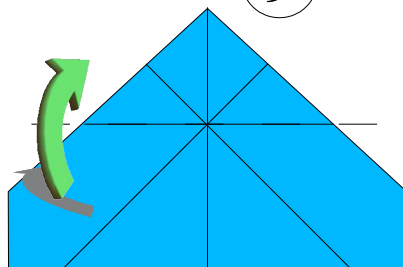

10

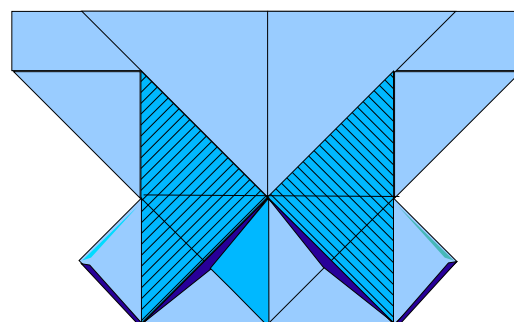
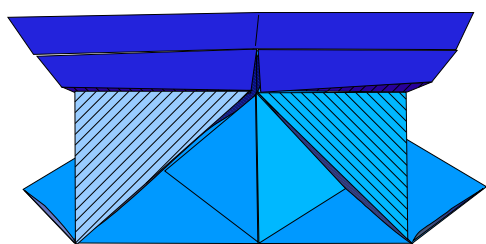

11

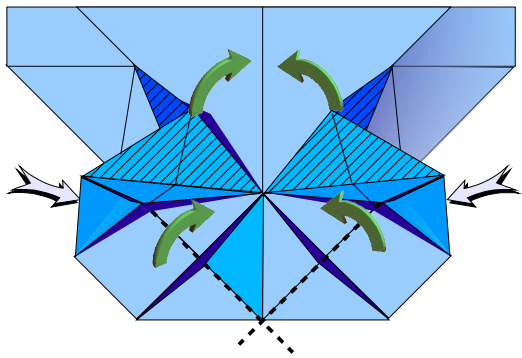

12

A partir de aquí se pueden hacer 2 aviones

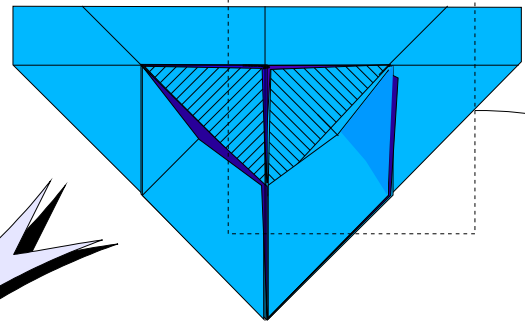
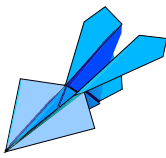

13₁

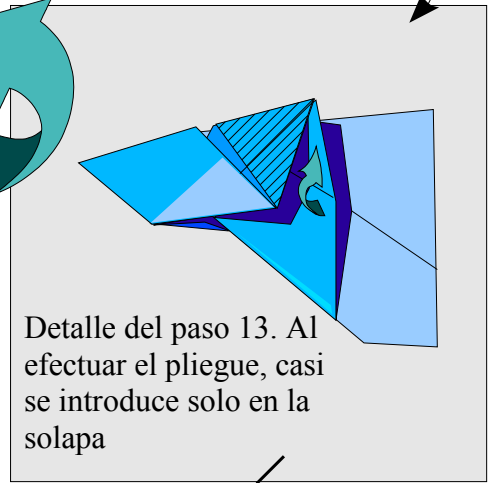
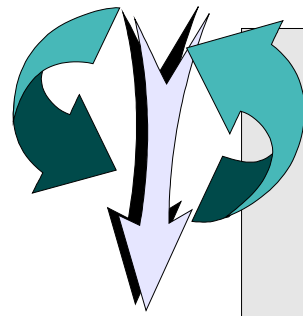
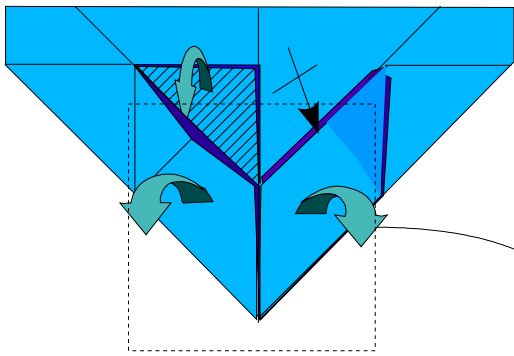

Detalle del paso 13. Al efectuar el pliegue, casi se introduce solo en la solapa

13₂

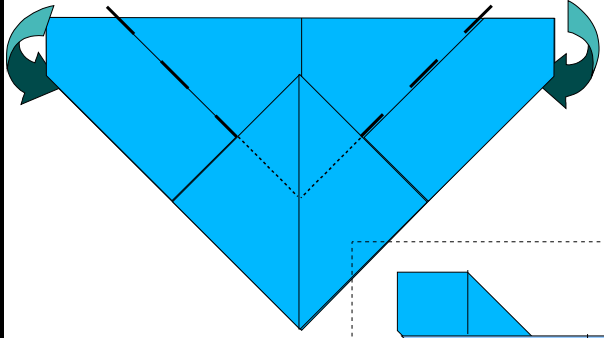

14₁

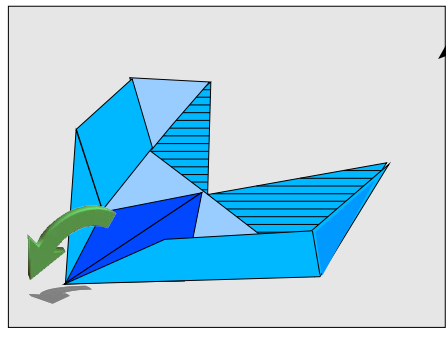

14₂

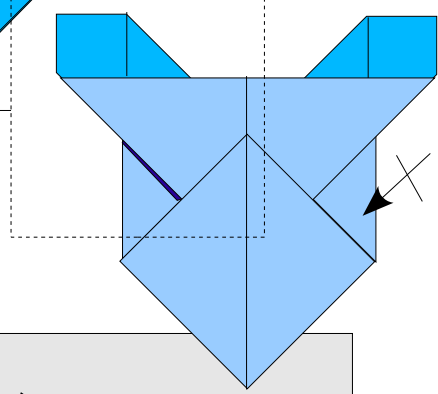

15₁

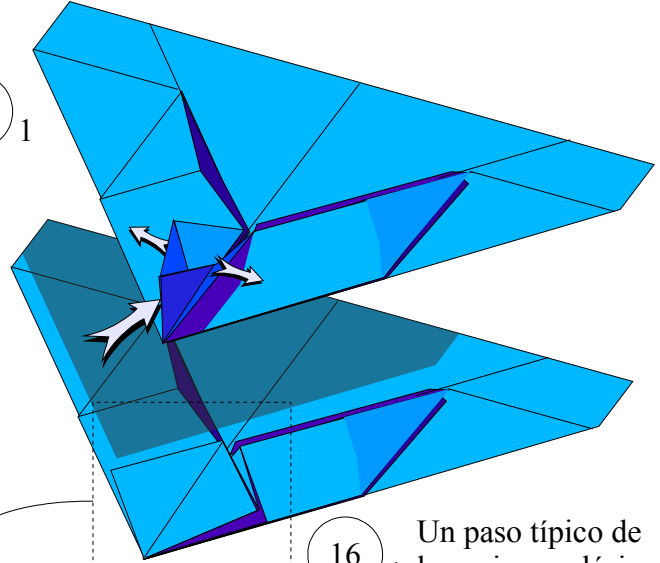

16₁ Un paso típico de los aviones clásicos

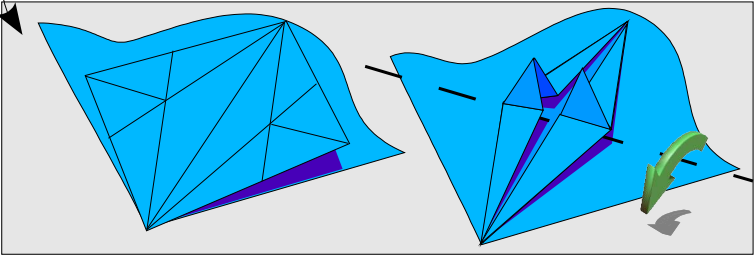
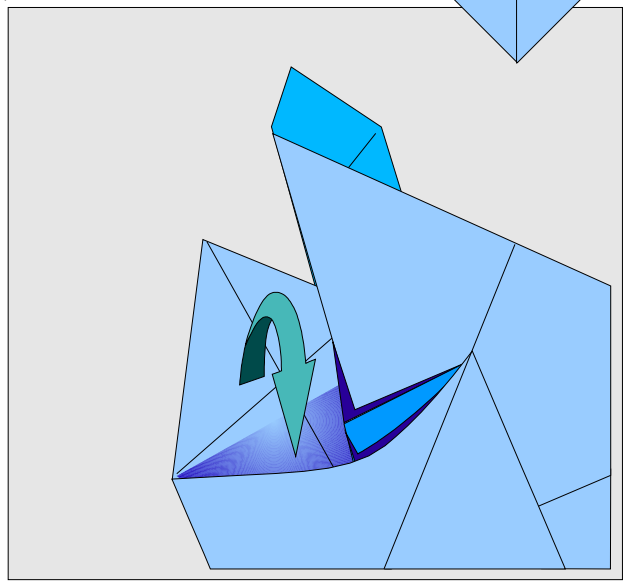

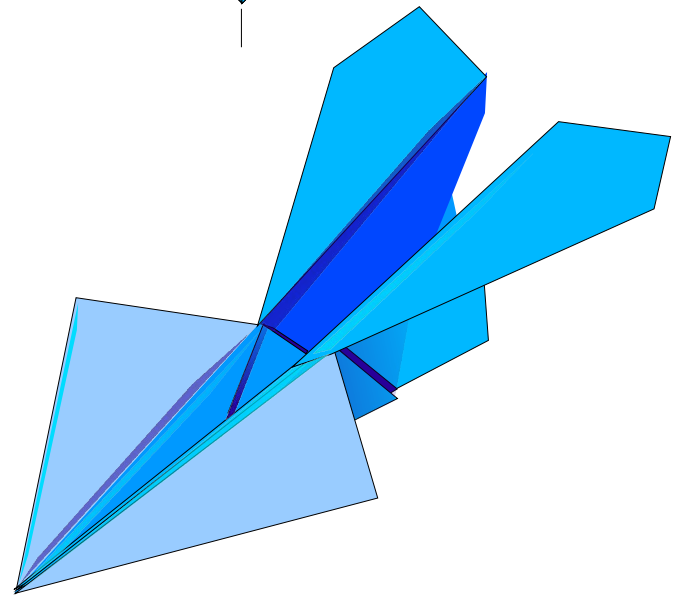
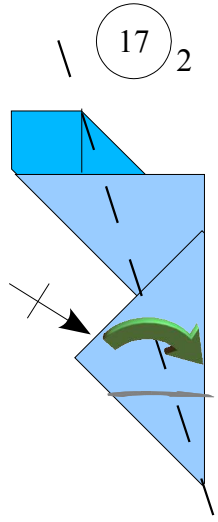
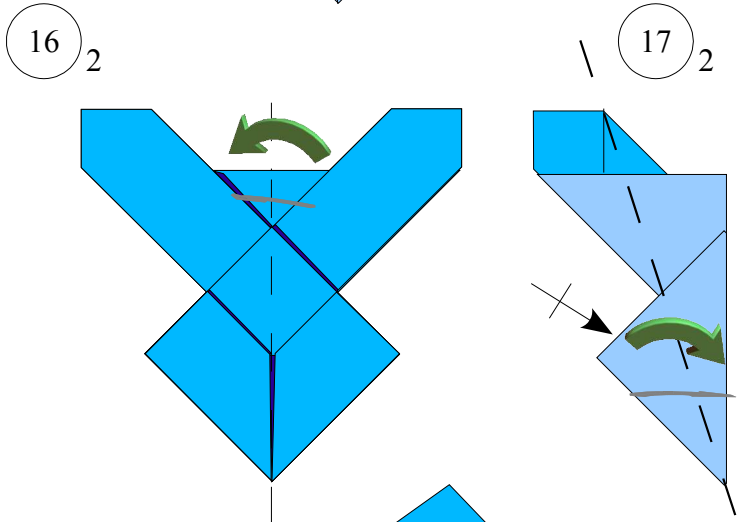
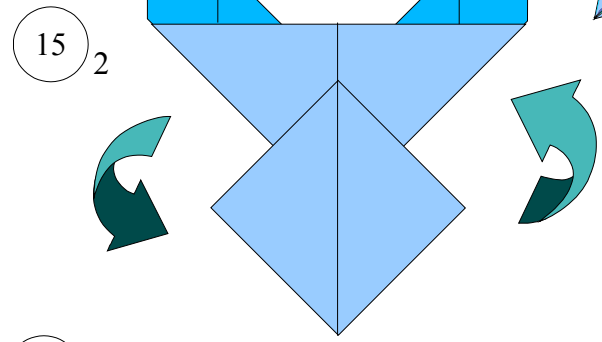
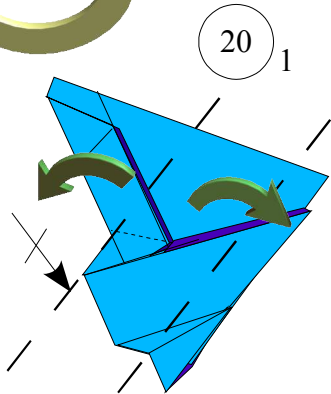
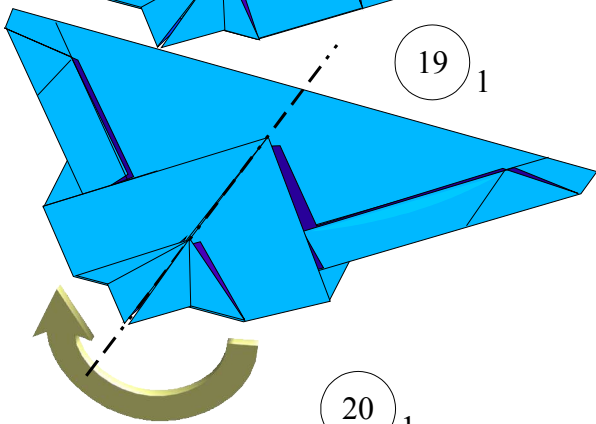
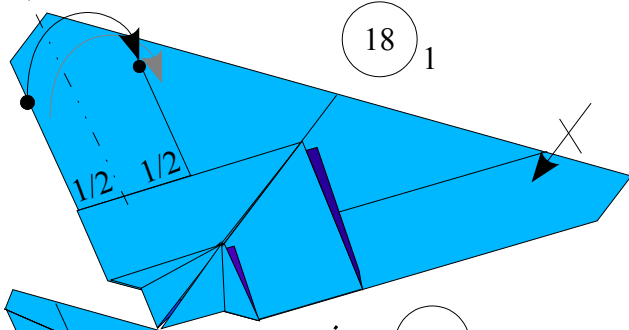
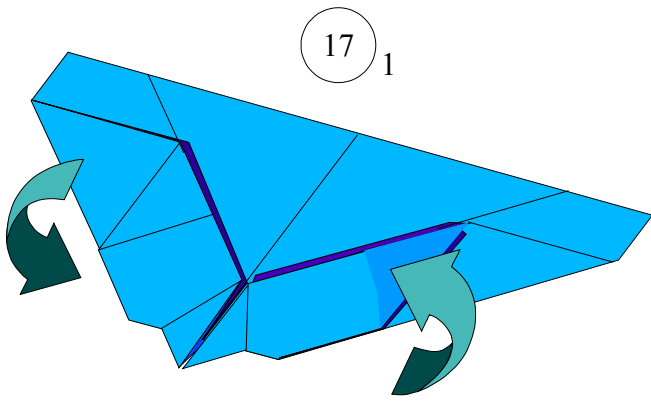

Hay que lanzarlos con fuerza, sujetándolos cerca de la punta. Para mejorar el vuelo, puede variarse el ángulo de las alas apretando más los pliegues, o aflojándolos un poco.

¡Pista libre! ;)